

HBGQ16 Pushbuttons Switch Series mounting hole : $\Phi 16$

Order Code - Configurazione di un modello

Configura un pulsante o un interruttore facendo uso della seguente simbologia :

★	■	◆	■	▲	▲	●
Fronte Front Shape	Contatti Contact configuration	Led Lamp Type	Contatti Oper. Type	Colore Led color	Volt Led Led voltage	Materiale Material
Y : round F : square J : rectangle M : mushroom head DF : big square DJ : big rectangle	10 : 1NO 11 : 1NO 1NC 22 : 2NO 2NC	D : indicator light Z : self-lock button X : select button Y : key button TS : push lock Pin button No letter: meaning self restoring	Z : latching X : selector Y : key-lock M : buzzer SM : flash buz. No letter : Pushbuttons Pulsante	R Red G Green Y Yellow O Orange B Blue W White	6 12 24 36 110 220	N = Nickel plated brass S = Stainless S. A = Zn-Al Alloy

Description - Descrizione	Figura	
Diagramm each single contact Schema elettrico (singolo contatto)		
Symbol Simbolo* The contact can to be NO (normally open) or NC (normally closed) Il contatto può essere NA (normalmente aperto) NC (Normalmente chiuso)		
Nota : Diagramm is referred for one single contact and one Led Riferito ad ogni singolo contatto	Contatti configurati : uno - due Led configurati : uno	

LampType	LED lamp(AC/DC)			Lamp Circuit Diagram
LEDColor	R G Y O B W			
Life	40000hours(Reference)			
RatedVoltage	AC/DC6V	AC/DC12V	AC/DC110V	
	AC/DC24V	AC/DC36V	AC/DC220V	
RatedCurrent	About15mA		About3mA	
Dropping Way	Innerresistance		Outerresistance when using6Vlamp	

Using AC/DC led lamp. Terminals have no difference of anode and cathode.
 Non c'è differenza di polarità ai terminali del led. Collegando una resistenza esterna si può adattare il funzionamento del led ad una tensione superiore : ad esempio il led interno è di 5V. Con una resistenza esterna da 1K il led può funzionare a 12V.

HBGQ16 Pushbuttons Switch Series mounting hole : Φ 16



Shape and Dimensions

Esempio d' ordine

HBGQ16F-10EJR12S Pulsante 1NA 16mm tipo Flat, ring led rosso, terminale a saldare, corpo Stainless Steel

HBGQ16H-10EJR12S Pulsante 1NA 16mm tipo High Round, ring led rosso, terminale a saldare, corpo Stainless Steel

Nell'ordine, completare il codice con le seguenti informazioni :

⊙ = tipo di materiale **NPB** = Nickel Plated Brass **S** = Stainless Steel

▲ ▲ = colore led - tensione led ■ ■ = operazione - n. contatti

Valori resistenze inseriti all'interno dei pulsanti luminosi a led.

Volendo adattare i led a valori di tensione diversi da quelli ordinati, si applica una resistenza esterna ad uno dei terminali led . Ad esempio, si desidera collegare un pulsante led con valore di tensione 12V ad una tensione di 24V : impiegare una resistenza esterna da 680 - 720 Ohm, ricavando il dato dalla differenza dei valori ohmici riportato nella tabella seguente.

Current Limiting Resistor Configuration Table	Rated Voltage				Formula
	6V	12V	24V	36V	
Current Limiting Resistor	210 Ω , 1/4W	510 Ω , 1/2W	1.2k Ω , 3/4W	2.2k Ω , 1W	$R = \frac{U-U_e}{I_e}$
	160 Ω , 1/4W	460 Ω , 1/2W	1.2k Ω , 3/4W	2.2k Ω , 1W	



Profili

Metal Pushbuttons with led

Parsic Italia

HBGQ16 SERIES mounting hole : Φ 16



- Mounting hole size : 16mm
- Switch rating : 2A 36VDC
- Contact configuration : 1 x NO
- Front shape : Flat Ring Led
- Operation type : Momentary
- Material : NPB or Stainless steel
- Protection degree : IP65 IK08



- Mounting hole size : 16mm
- Switch rating : 2A 36VDC
- Contact configuration : 1 x NO
- Front shape : High round Ring Led
- Operation type : Momentary
- Material : NPB or Stainless steel
- Protection degree : IP65 IK08

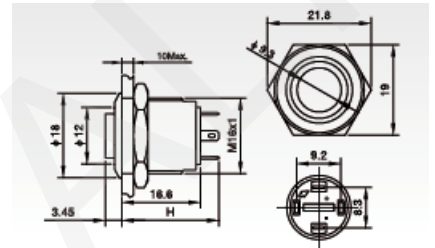
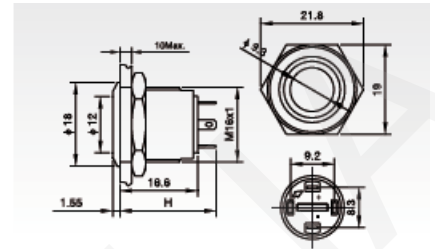

▲ ▲ ◎ = Color/Volt/Material

	HBGQ16F-10EJ ▲ ▲ ◎	HBS1-AGQH11E ▲ ▲ ◎
Terminal Type	Pin Terminal (2.0 x 0.5mm)	Pin Terminal (2.0 x 0.5mm)
Switch type	Two terminal breakpoints slow moving contract	Two terminal breakpoints moving contract
Switch specifications	Ith: 2A / Ui: 36VDC	Ith: 2A / Ui: 36VDC
Contact Resistance (m Ω)	≤ 50	≤ 50
Insulation Resistance (M Ω)	≥ 1000	≥ 1000
Dielectric Strength (VAC)	2000	2000
Operating Temperature	-20°C ~ +55°C	-20°C ~ +55°C
Mechanical Life (times)	> 1.000.000	> 1.000.000
Electrical Life (times)	> 200.000	> 200.000
Panel Thickness (mm)	1 ~ 10	1 ~ 6
Torque (Nm)	5 ~ 14	5 ~ 14
Operating Pressure (N)	about 4	about 4
Operating Stroke (mm)	about 1,5	about 1,5
Protection Degree	IP65, IK08	IP65, IK08
Contact	Silver Alloy	Silver Alloy
Button	Stainless Steel	Stainless Steel
Case	Stainless Steel/NPB	Stainless Steel/NPB
Base	PBT	PBT
Type	Dot illuminated LED	Ring illuminated
Rated Voltage (Vac-dc) Led	6/12/24/110/220	6/12/24/110/220
Color Led	R G Y O B W	R G Y O B W
Life L _{Amp}	50000 hours	

Metal Pushbuttons with led

HBGQ16 – HBGQ16M SERIES mounting hole : Φ 16



- Mounting hole size : 16mm
- Switch rating : 2A 36VDC
- Contact configuration : 1 x NO
- Front shape : Flat round dot Led
- Operation type : Momentary
- Material : NPB or Stainless steel
- Protection degree : IP65 IK08



- Mounting hole size : 16mm
- Switch rating : 2A 36VDC
- Contact configuration : 1 x NO
- Front shape : Front shape marshroom
- Operation type : Momentary
- Material : Zn –Al Alloy
- Protection degree : IP65 IK08

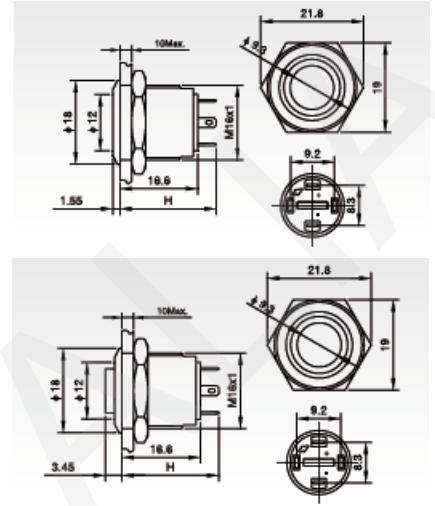

▲ ▲ ◎ = Color/Volt/Material	HBGQ16F-10DJ ▲ ▲ ◎	HBG16M-10DJ ▲ ▲ TA
Terminal Type	Pin Terminal (2.0 x 0.5mm)	Pin Terminal (2.0 x 0.5mm)
Switch type	Two terminal breakpoints slow moving contract	Two terminal breakpoints moving contract
Switch specifications	Ith: 2A / Ui: 36VDC	Ith: 2A / Ui: 36VDC
Contact Resistance (mΩ)	≤ 50	≤ 50
Insulation Resistance (MΩ)	≥ 1000	≥ 1000
Dielectric Strength (VAC)	2000	2000
Operating Temperature	-20°C ~ +55°C	-20°C ~ +55°C
Mechanical Life (times)	> 1.000.000	> 1.000.000
Electrical Life (times)	> 200.000	> 200.000
Panel Thickness (mm)	1 ~ 10	1 ~ 6
Torque (Nm)	5 ~ 14	5 ~ 14
Operating Pressure (N)	about 4	about 4
Operating Stroke (mm)	about 1,5	about 1,5
Protection Degree	IP65, IK08	IP65, IK08
Contact	Silver Alloy	Silver Alloy
Button	Stainless Steel	Zn-Al Alloy
Case	Stainless Steel/NPB	Zn-Al Alloy
Base	PBT	PBT
Type	Dot illuminated LED	Ring illuminated
Rated Voltage (Vac-dc) Led	6/12/24/110/220	6/12/24/110/220
Color Led	R G Y O B W	R G Y O B W
Life LAMP	50000 hours	

Metal Pushbuttons not illuminated

HBS2GQF - H SERIES not – illuminated mounting hole : Φ 16



HBS2GQF-11(22) ■ ■ ⊙ Flat round

- Mounting hole size : 16mm
- Switch rating : 3A 250V AC
- Contact configuration : 1 x NONC 2 x NONC
- Front shape : Flat Round
- Operation type : Momentary - Latching
- Material : NPB or Stainless steel
- Protection degree : IP40/IP67/ IK09

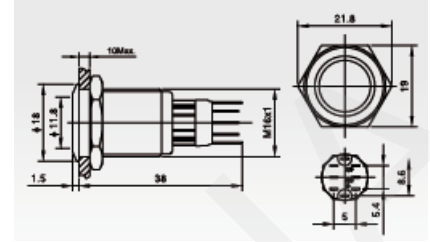

HBS2GQH-11(22) ■ ■ High round

- Mounting hole size : 16mm
- Switch rating : 2A 36VDC
- Contact configuration : 1 x NONC 2 x NONC
- Front shape : High round
- Operation type : Momentary - Latching
- Material : NPB or Stainless steel
- Protection degree : IP40/IP67/ IK08

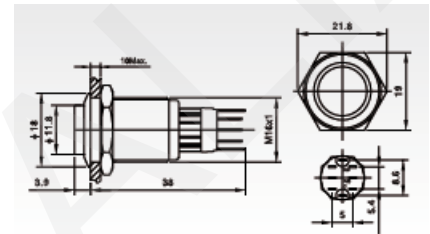

■ ■ ⊙ = Contact/Operation/Material

	HBS2GQF-11 ■ ■ ⊙	HBS2GQH-11 ■ ■ ⊙
Terminal Type	Pin Terminal (2.8 x 0.4mm)	Pin Terminal (2.8 x 0.4mm)
Switch type	Single breakpoint snap action changeover contacts	Single breakpoint snap action changeover contacts
Switch specifications	Ith: 3A / Ui: 250VAC	Ith: 3A / Ui: 250VAC
Contact Resistance (mΩ)	≤ 50	≤ 50
Insulation Resistance (MΩ)	≥ 1000	≥ 1000
Dielectric Strength (VAC)	2000	2000
Operating Temperature	-20°C ~ +55°C	-20°C ~ +55°C
Mechanical Life (times)	> 1.000.000	> 1.000.000
Electrical Life (times)	> 50.000	> 50.000
Panel Thickness (mm)	1 ~ 10	1 ~ 6
Torque (Nm)	5 ~ 14	5 ~ 14
Operating Pressure (N)	about 2,5 - 4	about 2,5 - 4
Operating Stroke (mm)	about 2,8	about 2,8
Protection Degree	IP40/67, IK09	IP40/67, IK08
Contact	Silver Alloy	Silver Alloy
Button	Stainless Steel	Stainless Steel
Case	Stainless Steel/NPB	Stainless Steel/NPB
Base	PBT	PBT

HBS2GQF - H SERIES not – illuminated mounting hole : Φ 16



HBS2GQG-11 (22) ■ ■ ⊙ Flat round

- Mounting hole size : 16mm
- Switch rating : 3A 250V AC
- Contact configuration : 1 x NONC 2xNONC
- Front shape : High concave Round
- Operation type : Momentary - Latching
- Material : NPB or Stainless steel
- Protection degree : IP40/IP67/ IK09

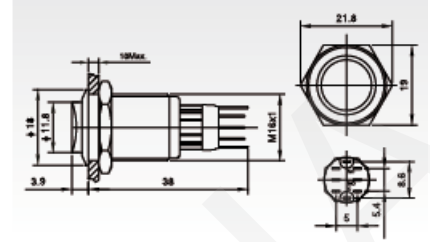

HBS2GQC-11(22) ■ ■ Concave round

- Mounting hole size : 16mm
- Switch rating : 2A 36VDC
- Contact configuration : 1 x NONC 2xNONC
- Front shape : Concave round
- Operation type : Momentary - Latching
- Material : NPB or Stainless steel
- Protection degree : IP40/IP67/ IK09

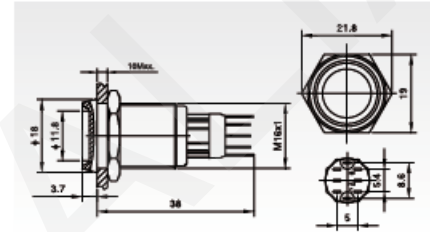

■ ■ ⊙ = Contact/Operation/Material

	HBS2GQG- ■ ■ ⊙	HBS2GQC- ■ ■ ⊙
Terminal Type	Pin Terminal (2.0 x 0.5mm)	Pin Terminal (2.0 x 0.5mm)
Switch type	Two terminal breakpoints slow moving contract	Two terminal breakpoints moving contract
Switch specifications	Ith: 3A / Ui: 250VAC	Ith: 3A / Ui: 250VAC
Contact Resistance (mΩ)	≤ 50	≤ 50
Insulation Resistance (MΩ)	≥ 1000	≥ 1000
Dielectric Strength (VAC)	2000	2000
Operating Temperature	-20°C ~ +55°C	-20°C ~ +55°C
Mechanical Life (times)	> 1.000.000	> 1.000.000
Electrical Life (times)	> 50.000	> 50.000
Panel Thickness (mm)	1 ~ 10	1 ~ 6
Torque (Nm)	5 ~ 14	5 ~ 14
Operating Pressure (N)	about 2,5 - 4	about 2,5 - 4
Operating Stroke (mm)	about 2,8	about 2,8
Protection Degree	IP40/67, IK09	IP40/67, IK08
Contact	Silver Alloy	Silver Alloy
Button	Stainless Steel	Stainless Steel
Case	Stainless Steel/NPB	Stainless Steel/NPB
Base	PBT	PBT

Metal Pushbuttons with led

Parsic Italia

HBS2GQF SERIES mounting hole : Φ 16

Flat round Power symbol



HBS2GQF-D T ■ ■ ▲ ▲ ◎

- Mounting hole size : 16mm
- Switch rating : 3A 250V AC
- Contact configuration : 1 x NONC 2xNONC
- Front shape : Flat round power symbol
- Operation type : Momentary - Latching
- Material : NPB or Stainless steel
- Protection degree : IP40/IP67/ IK09

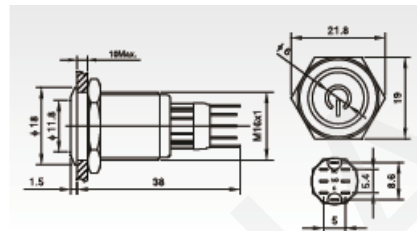

Esempio codice ordine : HBS2GQF-11DRTN12 = Pulsante NPB dot rosso, un contatto 12V . Se interruttore HBS2GQF-11DZRN12
 HBS2GQF-11DRT11S12 = Pulsante St.St. dot rosso, un contatto 12V . Se interruttore HBS2GQF-DZR11S12
 HBS2GQF-22DRTN12 = Pulsante NPB dot rosso, due contatti 12V . Se interruttore HBS2GQF-22DZRN12
 HBS2GQF-22DRT11S12 = Pulsante St.St. dot rosso, due contatti 12V . Se interruttore HBS2GQF-DZR22S12

▲ ■ ■ ◎ ▲ =

Color/Contact/Operation/Material/Volt

HBS2GF-D- ▲ ▲ ■ ■ ◎

Color/Contact/Operation/Material/Volt	HBS2GF-D- ▲ ▲ ■ ■ ◎	
Terminal Type	Pin Terminal (2.0 x 0.5mm)	
Switch type	Single breakpoints snap action changeover contacts	
Switch specifications	Ith: 3A / Ui: 250VAC	
Contact Resistance (m Ω)	≤ 50	
Insulation Resistance (M Ω)	≥ 1000	
Dielectric Strength (VAC)	2000	
Operating Temperature	-20°C ~ +55°C	
Mechanical Life (times)	> 1.000.000	
Electrical Life (times)	> 50.000	
Panel Thickness (mm)	1 ~ 10	
Torque (Nm)	5 ~ 14	
Operating Pressure (N)	about 2,5 - 4	
Operating Stroke (mm)	about 2,8	
Protection Degree	IP40/67, IK09	
Contact	Silver Alloy	
Button	Stainless Steel	
Case	Stainless Steel/NPB	
Base	PBT	
Type	Dot illuminated LED	
Rated Voltage (Vac-dc) Led	6/12/24/110/220	
Color Led	R G Y O B W	
Life Led	50000 hours	

Metal Pushbuttons with led

HBS2GQF - H SERIES mounting hole : Φ 16

Flat round



HBS2GQF-D ■ ■ ■ ▲ ▲ ●

- Mounting hole size : 16mm
- Switch rating : 3A 250V AC
- Contact configuration : 1 x NONC 2xNONC
- Front shape : High concave Round
- Operation type : Momentary - Latching
- Material : NPB or Stainless steel
- Protection degree : IP40/IP67/ IK09

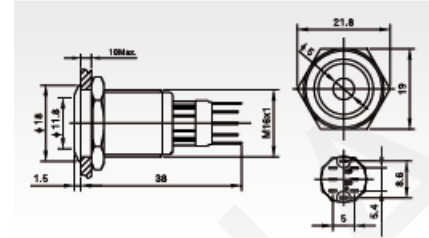

High round



HBS2GQH-D ■ ■ ■ ▲ ▲ ●

- Mounting hole size : 16mm
- Switch rating : 3A 250V AC
- Contact configuration : 1 x NONC 2xNONC
- Front shape : Concave round
- Operation type : Momentary - Latching
- Material : NPB or Stainless steel
- Protection degree : IP40/IP67/ IK09

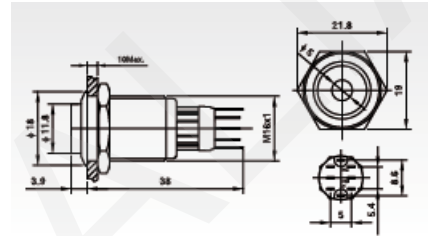

Esempio codice ordine : HBS2GQH-DR11N12 = Pulsante NPB dot rosso, un contatto 12V . Se interruttore HBSGQH-DRZ11N12
 HBS2GQH-DR11S12 = Pulsante St.St. dot rosso, un contatto 12V . Se interruttore HBSGQH-DRZ11S12

▲ ■ ■ ● ▲ =

Color/Contact/Operation/Material/Volt

HBS2GF-D- ▲ ▲ ■ ■ ●

HBS2GQ- D- ▲ ▲ ■ ■ ●

Terminal Type	Pin Terminal (2.0 x 0.5mm)	Pin Terminal (2.0 x 0.5mm)
Switch type	Single breakpoints snap action changeover contacts	Single breakpoints snap action changeover contacts
Switch specifications	Ith: 3A / Ui: 250VAC	Ith: 3A / Ui: 250VAC
Contact Resistance (mΩ)	≤ 50	≤ 50
Insulation Resistance (MΩ)	≥ 1000	≥ 1000
Dielectric Strength (VAC)	2000	2000
Operating Temperature	-20°C ~ +55°C	-20°C ~ +55°C
Mechanical Life (times)	> 1.000.000	> 1.000.000
Electrical Life (times)	> 50.000	> 50.000
Panel Thickness (mm)	1 ~ 10	1 ~ 6
Torque (Nm)	5 ~ 14	5 ~ 14
Operating Pressure (N)	about 2,5 - 4	about 2,5 - 4
Operating Stroke (mm)	about 2,8	about 2,8
Protection Degree	IP40/67, IK09	IP40/67, IK08
Contact	Silver Alloy	Silver Alloy
Button	Stainless Steel	Stainless Steel
Case	Stainless Steel/NPB	Stainless Steel/NPB
Base	PBT	PBT
Type	Dot illuminated LED	Ring illuminated
Rated Voltage (Vac-dc) Led	6/12/24/110/220	6/12/24/110/220
Color Led	R G Y O B W	R G Y O B W
Life Led	50000 hours	

Metal Pushbuttons with led

HBS2GQF - H SERIES mounting hole : Φ 16

High round



HBS2GQH- ■ ■ ▲ ▲ ●

- Mounting hole size : 16mm
- Switch rating : 3A 250V AC
- Contact configuration : 1 x NONC 2xNONC
- Front shape : High round
- Operation type : Momentary - Latching
- Material : NPB or Stainless steel
- Protection degree : IP40/IP67/ IK09

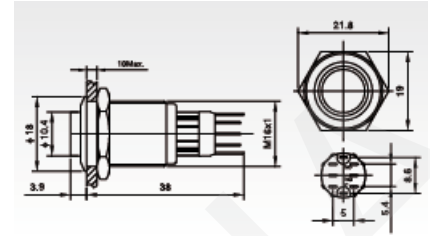

Flat round



HBS2GQF- ■ ■ ▲ ▲ ●

- Mounting hole size : 16mm
- Switch rating : 3A 250V AC
- Contact configuration : 1 x NONC 2xNONC
- Front shape : Flat round
- Operation type : Momentary - Latching
- Material : NPB or Stainless steel
- Protection degree : IP40/IP67/ IK09

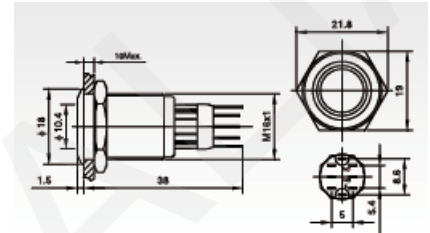

Esempio codice ordine : HBS2GQH-R11EN12 = Pulsante NPB dot rosso, un contatto 12V . Se interruttore HBSGQH-R11EN12
 HBS2GQF-R11ES12 = Pulsante St.St. dot rosso, un contatto 12V . Se interruttore HBSGQF-R11ZES12

▲ ■ ● ● ▲ =

Color/Contact/Operation/Material/Volt

HBS2GF-D- ▲ ▲ ■ ■ ●

HBS2GQ- D- ▲ ▲ ■ ■ ●

Terminal Type	Pin Terminal (2.0 x 0.5mm)	Pin Terminal (2.0 x 0.5mm)
Switch type	Single breakpoints snap action changeover contacts	Single breakpoints snap action changeover contacts
Switch specifications	Ith: 3A / Ui: 250VAC	Ith: 3A / Ui: 250VAC
Contact Resistance (mΩ)	≤ 50	≤ 50
Insulation Resistance (MΩ)	≥ 1000	≥ 1000
Dielectric Strength (VAC)	2000	2000
Operating Temperature	-20°C ~ +55°C	-20°C ~ +55°C
Mechanical Life (times)	> 1.000.000	> 1.000.000
Electrical Life (times)	> 50.000	> 50.000
Panel Thickness (mm)	1 ~ 10	1 ~ 6
Torque (Nm)	5 ~ 14	5 ~ 14
Operating Pressure (N)	about 2,5 - 4	about 2,5 - 4
Operating Stroke (mm)	about 2,8	about 2,8
Protection Degree	IP40/67, IK09	IP40/67, IK08
Contact	Silver Alloy	Silver Alloy
Button	Stainless Steel	Stainless Steel
Case	Stainless Steel/NPB	Stainless Steel/NPB
Base	PBT	PBT
Type	Dot illuminated LED	Ring illuminated
Rated Voltage (Vac-dc) Led	6/12/24/110/220	6/12/24/110/220
Color Led	R G Y O B W	R G Y O B W
Life Led	50000 hours	

Metal Pushbuttons with led

HBS2GQPF - PH SERIES mounting hole : Φ 16

High round 0 degree slope



HBS2GQPH- ■ ■ ▲ ▲ ◎

- Mounting hole size : 16mm
- Switch rating : 3A 250V AC
- Contact configuration : 1 x NONC 2xNONC
- Front shape : High round 0 degree slope
- Operation type : Momentary - Latching
- Material : NPB or Stainless steel
- Protection degree : IP40/IP67/ IK09

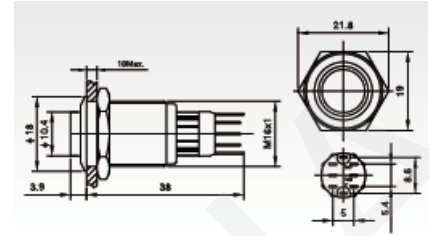

Flat 0 degree slope



HBS2GQPF- ■ ■ ▲ ▲ ◎

- Mounting hole size : 16mm
- Switch rating : 3A 250V AC
- Contact configuration : 1 x NONC 2xNONC
- Front shape : Flat 0 degree slope
- Operation type : Momentary - Latching
- Material : NPB or Stainless steel
- Protection degree : IP40/IP67/ IK09

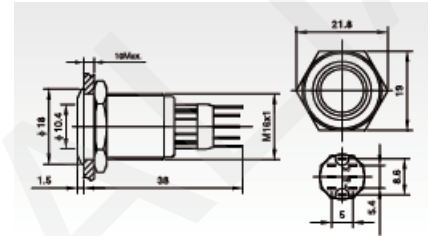

Esempio codice ordine : HBS2GQPH-R11EN12 = Pulsante NPB dot rosso, un contatto 12V . Se interruttore HBSGQPH-R11EN12
 HBS2GQPF-R11ES12 = Pulsante St.St. dot rosso, un contatto 12V . Se interruttore HBSGQPF-R11ES12

▲ ■ ■ ◎ ▲ =

Color/Contact/Operation/Material/Volt

HBS2GPH- ▲ ▲ ■ ■ ◎

HBS2GQPF- ▲ ▲ ■ ■ ◎

Terminal Type	Pin Terminal (2.0 x 0.5mm)	Pin Terminal (2.0 x 0.5mm)
Switch type	Single breakpoints snap action changeover contacts	Single breakpoints snap action changeover contacts
Switch specifications	Ith: 3A / Ui: 250VAC	Ith: 3A / Ui: 250VAC
Contact Resistance (mΩ)	≤ 50	≤ 50
Insulation Resistance (MΩ)	≥ 1000	≥ 1000
Dielectric Strength (VAC)	2000	2000
Operating Temperature	-20°C ~ +55°C	-20°C ~ +55°C
Mechanical Life (times)	> 1.000.000	> 1.000.000
Electrical Life (times)	> 50.000	> 50.000
Panel Thickness (mm)	1 ~ 10	1 ~ 6
Torque (Nm)	5 ~ 14	5 ~ 14
Operating Pressure (N)	about 2,5 - 4	about 2,5 - 4
Operating Stroke (mm)	about 2,8	about 2,8
Protection Degree	IP40/67, IK09	IP40/67, IK08
Contact	Silver Alloy	Silver Alloy
Button	Stainless Steel	Stainless Steel
Case	Stainless Steel/NPB	Stainless Steel/NPB
Base	PBT	PBT
Type	Dot illuminated LED	Ring illuminated
Rated Voltage (Vac-dc) Led	6/12/24/110/220	6/12/24/110/220
Color Led	R G Y O B W	R G Y O B W
Life Led	50000 hours	